

1 manuals.singer.com

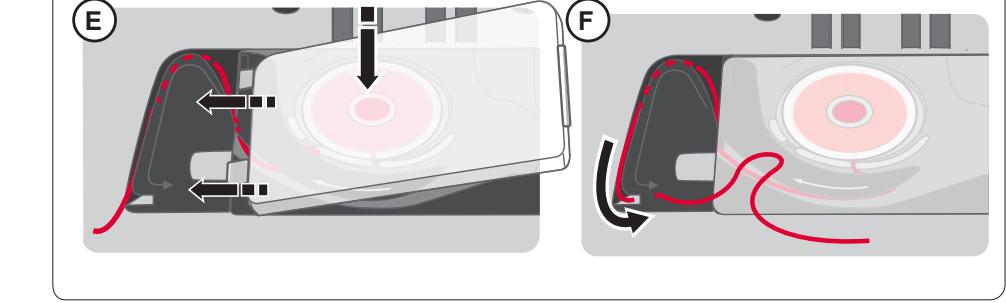
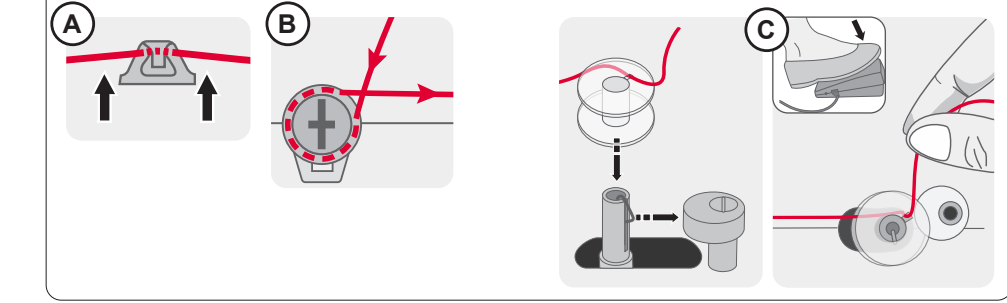
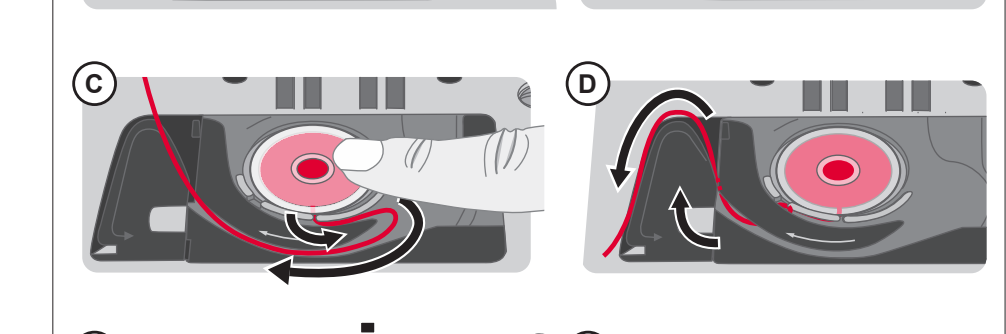
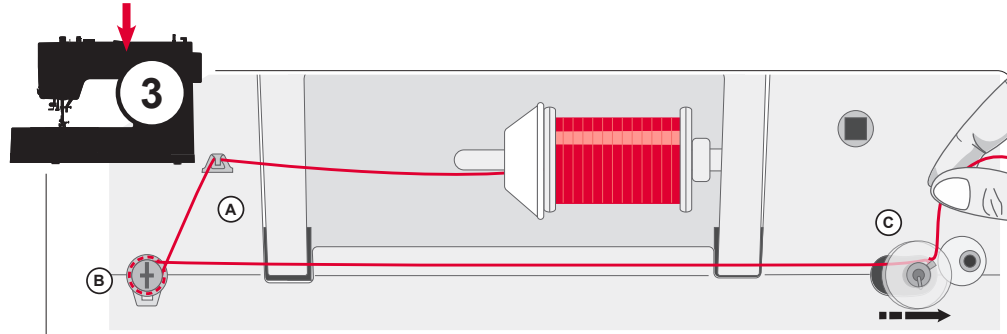
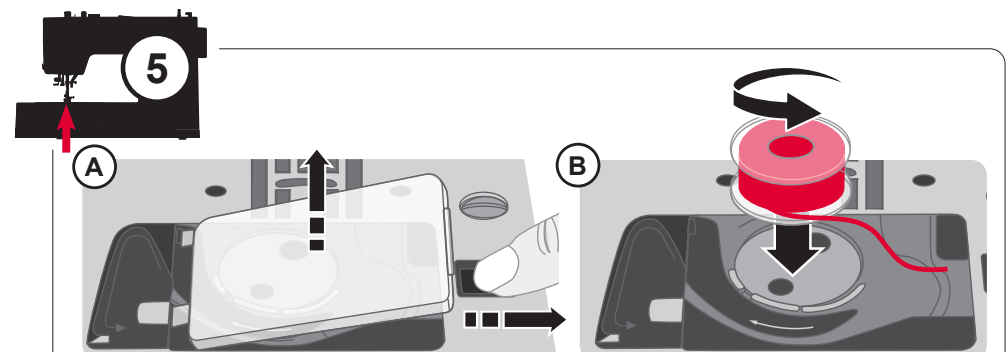
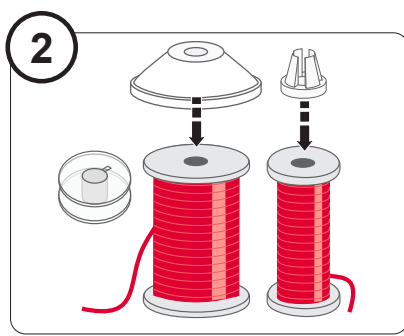
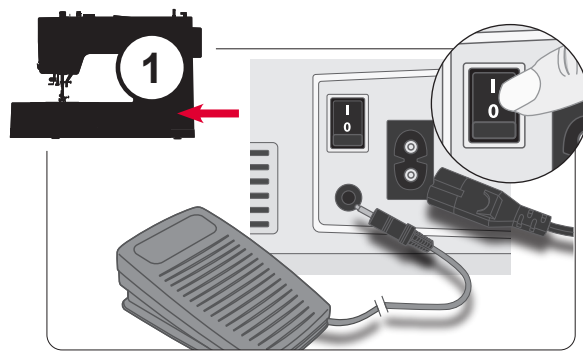
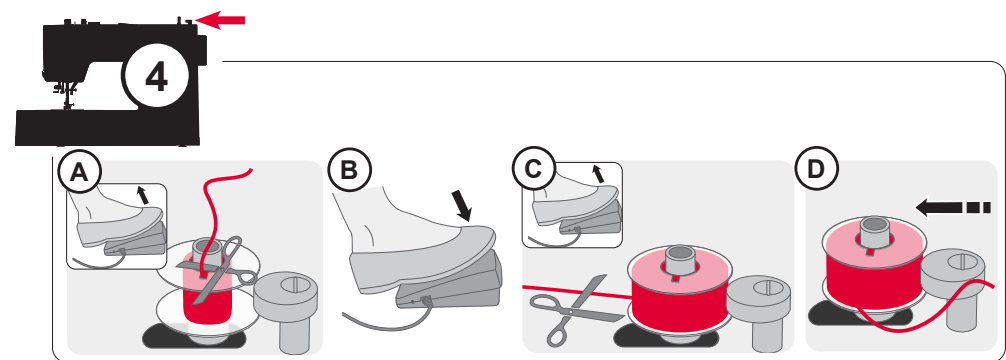
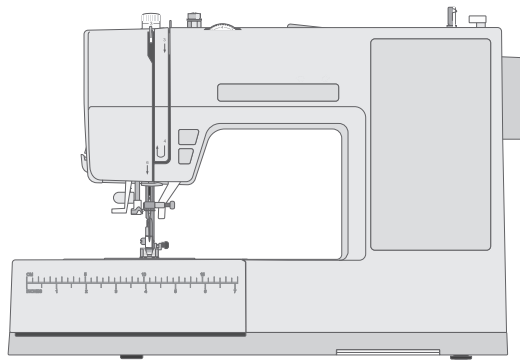

4710716-96A SINGER and the Cameo "S" design are exclusive trademarks of The Singer Company Limited S.à.r.l. or its Affiliates. ©2020 The Singer Company Limited S.à.r.l. or its Affiliates. All rights reserved.

SINGER et le Cameo « S » Design sont des marques déposées de The Singer Company Limited S.à.r.l. ou ses sociétés affiliées. ©2020 The Singer Company Limited S.à.r.l. ou ses sociétés affiliées. Tous droits réservés.

SINGER und das Cameo „S“ Design sind exklusive Warenzeichen von The Singer Company Limited S.à.r.l. bzw. Zugehörigen Tochterunternehmen. ©2020 The Singer Company Limited S.à.r.l. oder damit verbundene Unternehmen. Alle Rechte vorbehalten.

SINGER e Cameo "S" Design sono marchi commerciali esclusivi di The Singer Company Limited S.à.r.l. o delle sue affiliate. ©2020 The Singer Company Limited S.à.r.l. o sue affiliate. Tutti i diritti riservati.

SINGER y el diseño del Cameo "S" son marcas comerciales exclusivas de The SINGER Company Limited S.à.r.l. o sus afiliados. ©2020 The Singer Company Limited S.à.r.l. o sus Afiliados. Todos los derechos reservados.

SINGER en het ovale "S" design zijn exclusieve handelsmerken van The Singer Company Limited S.à.r.l. of haar dochterondernemingen. ©2020 The SINGER Company Limited S.à.r.l. of haar dochterondernemingen. Alle rechten voorbehouden.

SINGER och "S"-emblemät är varumärken tillhörande The Singer Company Limited S.à.r.l. eller dess dotterbolag. ©2020 The Singer Company Limited S.à.r.l. eller dess dotterbolag. Med ensamrätt.

SINGER og "S"-designet i kamé er varemærker tilhørende The Singer Company Limited S.à.r.l. eller dets tilknyttede selskaber. ©2020 The Singer Company Limited S.à.r.l. eller dets tilknyttede selskaber. Alle rettigheder forbeholdes.

SINGER og det ovale "S"-symbolet er varemærker tilhørende The Singer Company Limited S.à.r.l. eller deres tilknyttede selskaper. ©2020 The Singer Company Limited S.à.r.l. eller deres tilknyttede selskaper. Med enerett.

SINGER ja "S" Design ovat The Singer Company Limited S.à.r.l:n tai sen tytäryhtiöiden tavaramerkkejä. ©2020 The Singer Company Limited S.à.r.l. tai sen tytäryhtiöt. Kaikki oikeudet pidätetään.

SINGER a Cameo "S" Design jsou výhradní ochranné známky společnosti The Singer Company Limited S.à.r.l. nebo jejich přidružených společností. ©2020 The Singer Company Limited S.à.r.l. nebo jejich přidružených společností. Všechna práva vyhrazena.

